

22"/56cm Reflector Accessory

Date Project Part #



22" Reflector + 22" Conical Lens
(Reflector not included)

Features

- Widens base luminaire distribution
- Hides the LEDs from view
- Quick and easy installation – simply snap into reflector with supplied metal ring
- See website for Installation Guide/IES files

Compatible Products

- Aluminum Bell 22" Reflector
- Prismatic 22" Reflector

Mechanical

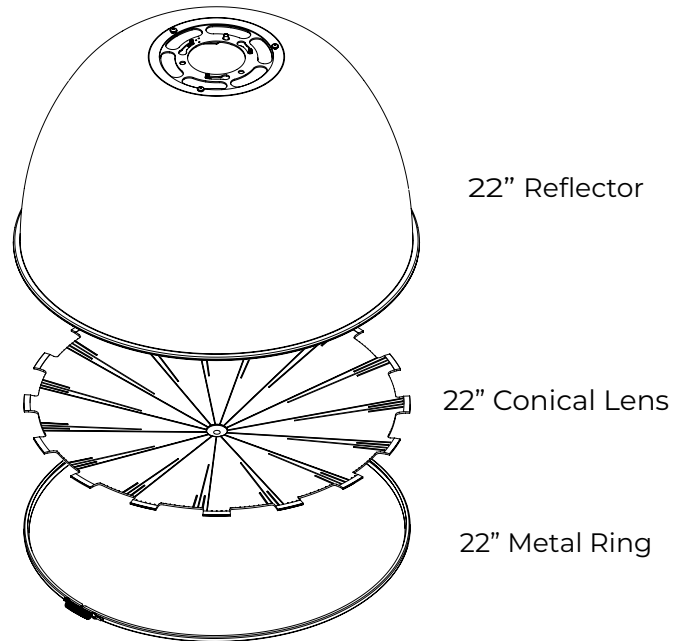
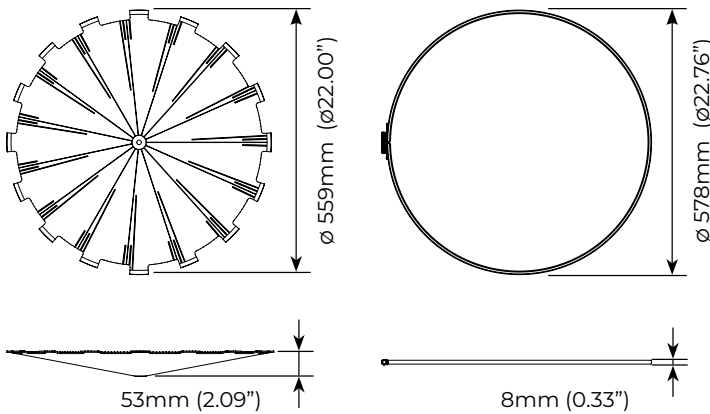

Ordering Information

Description	Part Code	Part Number	Quick Ship
22" Conical Lens	03875	ACC-022-CNL-000-FL	Yes

1. Unless otherwise specified, all values are typical at 25°C, 240VAC
 2. [See limited warranty for details](#)
 3. Specifications subject to change without notice

4. Not intended for use in environments containing airborne corrosive agents such as chemicals, solvents, or cutting fluids