

Luminaire

Works direct to line 100-277 VAC line

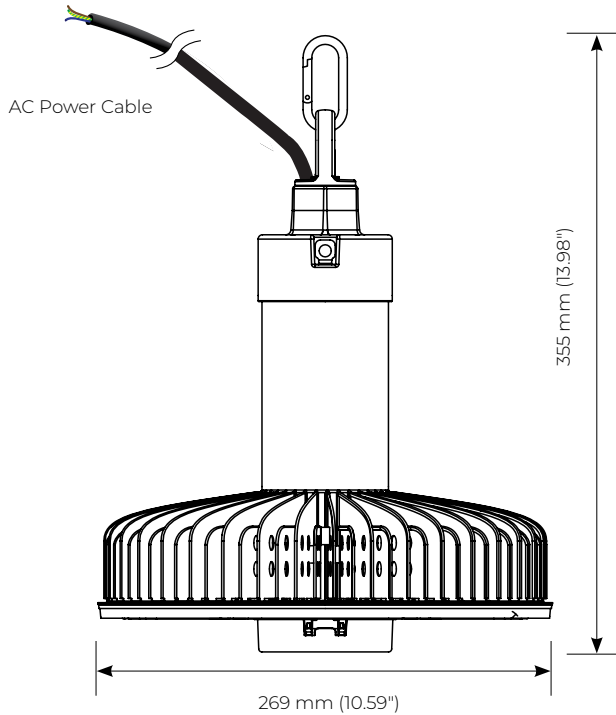

North America / Japan / Korea / Mexico

Applies to UL certified luminaires
Cable Wire Color

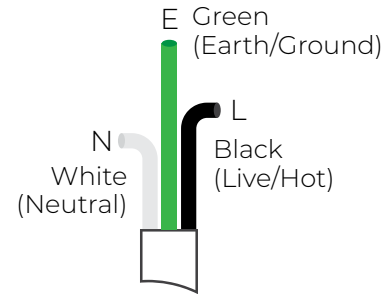

Europe / Asia / Australia / Japan / Korea

Applies to CE certified luminaires
Cable Wire Color

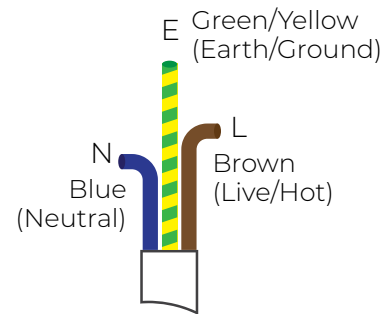

Option to remove carabiner for mounting to 3/4" NPT pipe

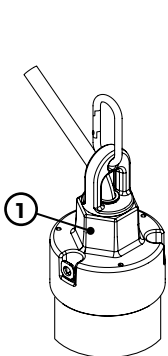

1. Clamp bottom head assembly holding it fixed

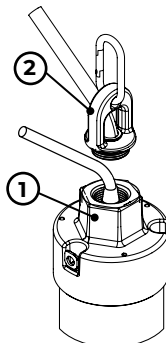

2. Unscrew top from bottom head assembly while holding bottom head assembly fixed

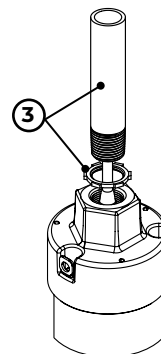

3. Insert locking nut (not provided) and 3/4" NPT Pipe onto head assembly

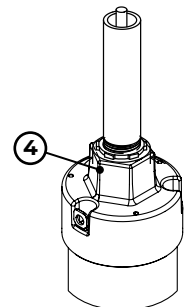

4. Tighten locking nut on to bottom head assembly

- WARNING -** DISCONNECT OR TURN OFF POWER BEFORE INSTALLATION OR SERVICING.

- WARNING -** VERIFY THAT SUPPLY VOLTAGE IS CORRECT BY COMPARING IT WITH THE LUMINAIRE LABEL.

- WARNING -** THE LUMINAIRE SHALL BE INSTALLED BY A QUALIFIED ELECTRICIAN AND WIRED IN ACCORDANCE WITH THE LATEST IEE OR NEMA ELECTRICAL REGULATIONS OR THE NATIONAL REQUIREMENTS.

- WARNING -** MAKE ALL ELECTRICAL AND GROUNDED CONNECTIONS IN ACCORDANCE WITH ANY APPLICABLE LOCAL CODE REQUIREMENTS.

- WARNING -** ALL WIRING CONNECTIONS SHOULD BE CAPPED WITH APPROVED RECOGNIZED WIRE CONNECTORS.

- WARNING -** ALLOW LAMP/FIXTURE TO COOL BEFORE HANDLING. DO NOT TOUCH ENCLOSURE OR LIGHT SOURCE.

- WARNING -** FOLLOW ALL MANUFACTURER'S WARNINGS, RECOMMENDATIONS AND RESTRICTIONS FOR: DRIVER TYPE, BURNING POSITION, MOUNTING LOCATIONS/METHODS, REPLACEMENT AND RECYCLING.

- WARNING -** IF THE EXTERNAL FLEXIBLE CABLE OR CORD OF THIS LUMINAIRE IS DAMAGED, IT SHALL BE EXCLUSIVELY REPLACED BY THE MANUFACTURER OR HIS SERVICE AGENT OR A SIMILAR QUALIFIED PERSON IN ORDER TO AVOID A HAZARD.

- WARNING -** THE LIGHT SOURCE OF THIS LUMINAIRE IS NOT REPLACEABLE; WHEN THE LIGHT SOURCE REACHES ITS END OF LIFE THE WHOLE LUMINAIRE SHALL BE REPLACED.

- WARNING -** YOU MUST CONNECT THE INPUT POWER CABLE TO THE POWER SUPPLY USING THE SAME IP LEVEL AND A JUNCTION BOX WITH A CORD ANCHORAGE DEVICE.